

CUTSHEET

Front View

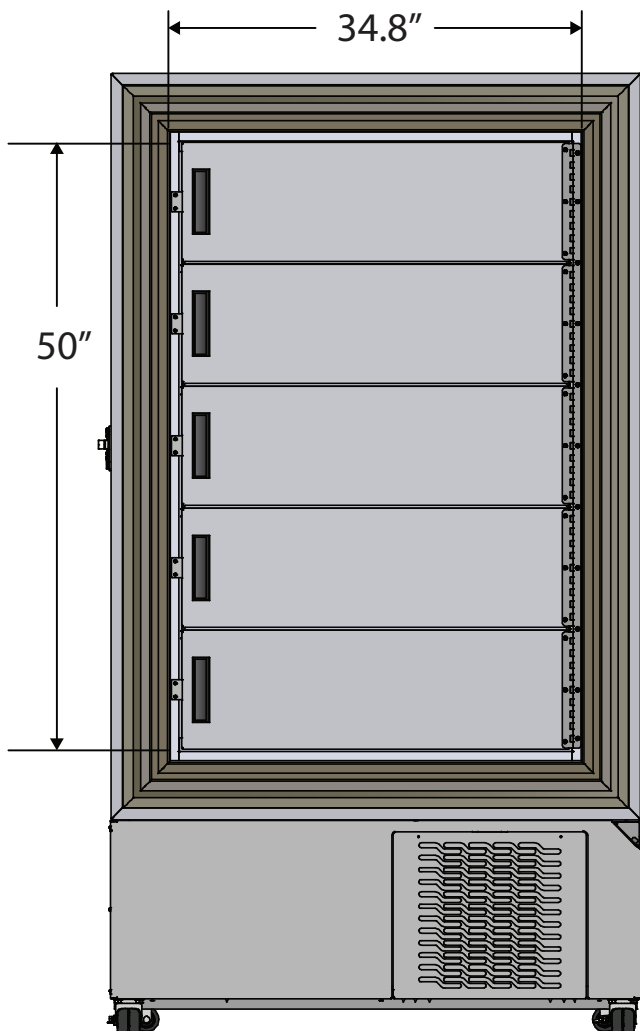

Side View

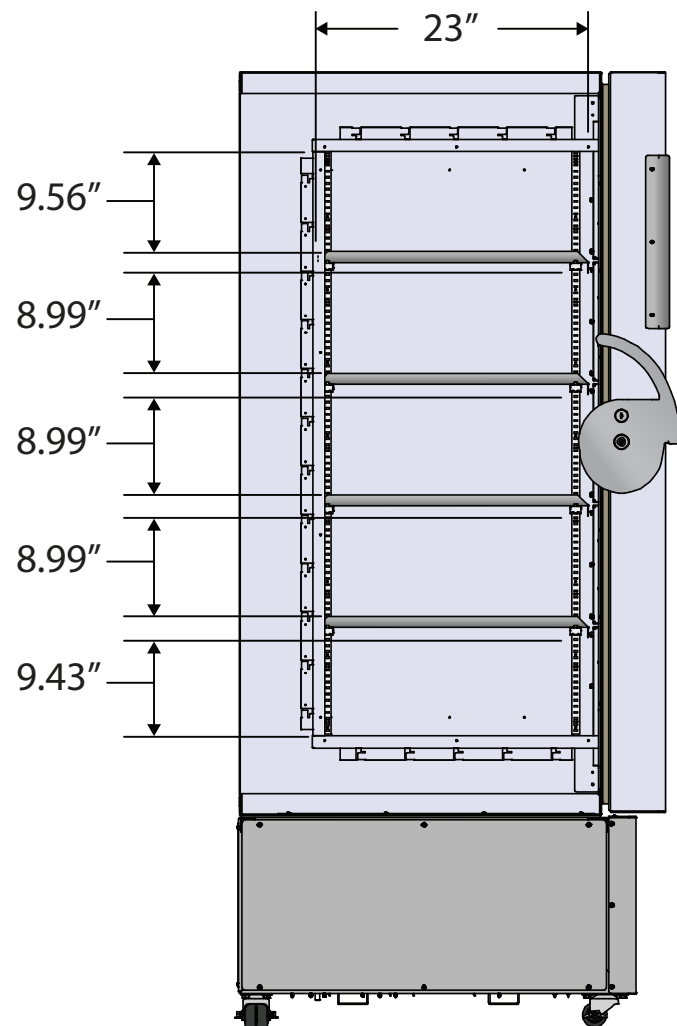

230VAC/60Hz/1PH
NEMA-6-15P

Cu. Ft	Defrost	Door	Int Door	Shelves	Interior Dim.			H.P.	Amps	Weight
					W"	D"	H"			
25	Manual	1 Solid	5	4 Fixed	34.8	23	50	½ x ½	10	730 lbs.

Note: Interior dimensions are estimates and subject to change without notice