

CUTSHEET

Front View

Side View

Top View

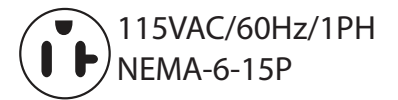
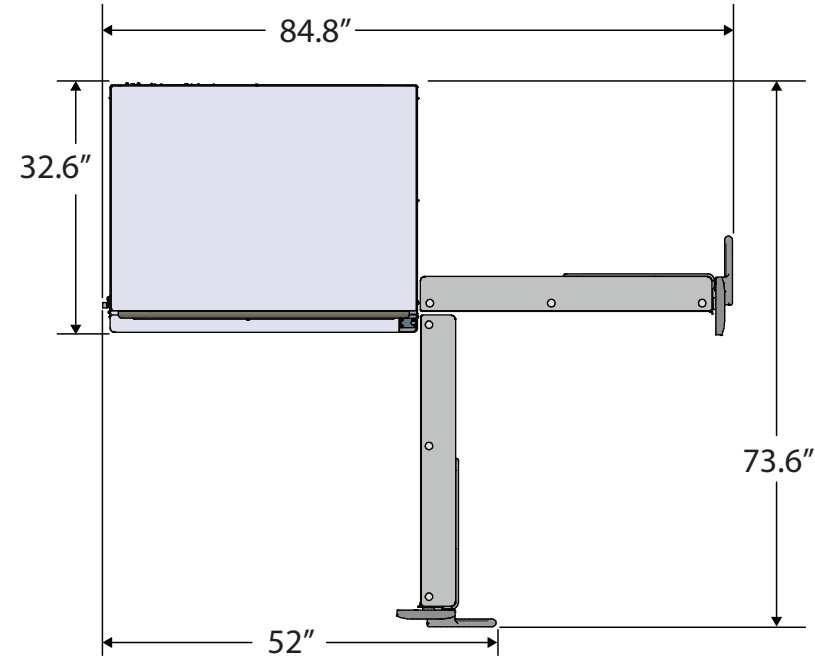
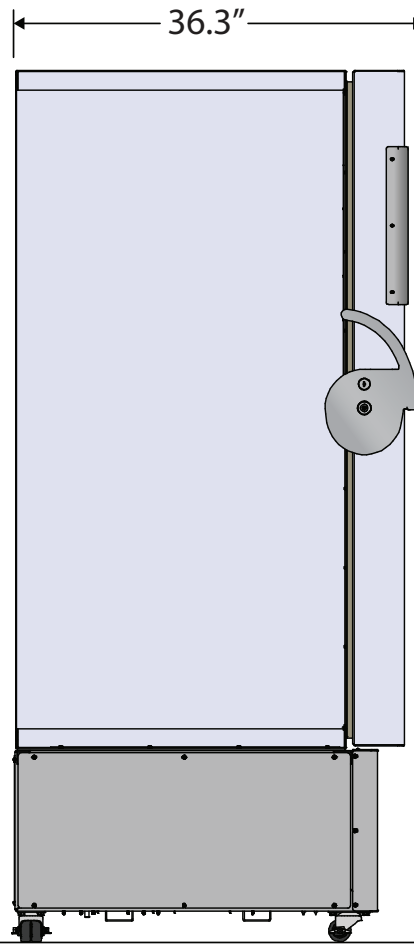
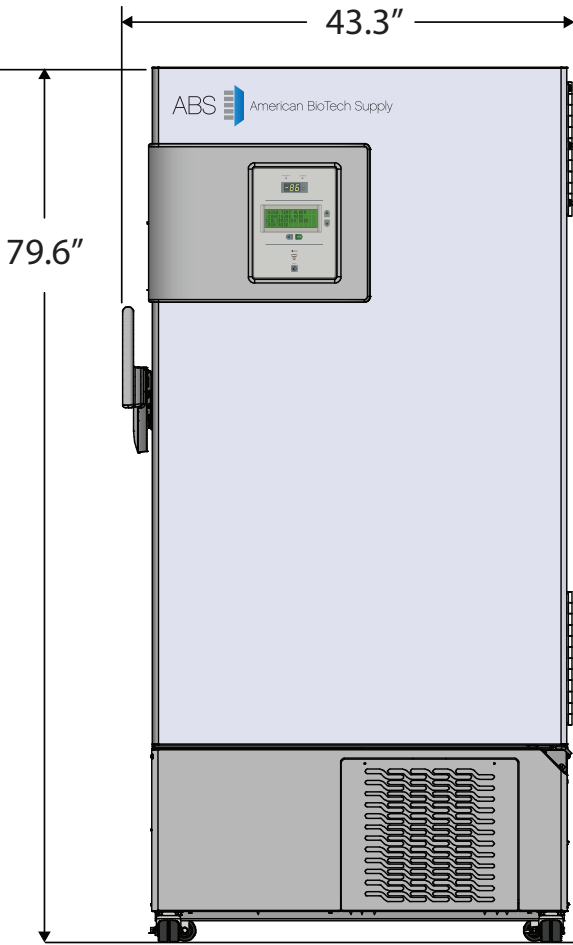

Cu. Ft	Defrost	Door	Int Door	Shelves	W"	D"	H"	H.P.	Amps	Weight
21	Manual	1 Solid	5	4 Fixed	43.3	36.3	79.6	½ x ½	16	680 lbs.