

CUTSHEET

Front View

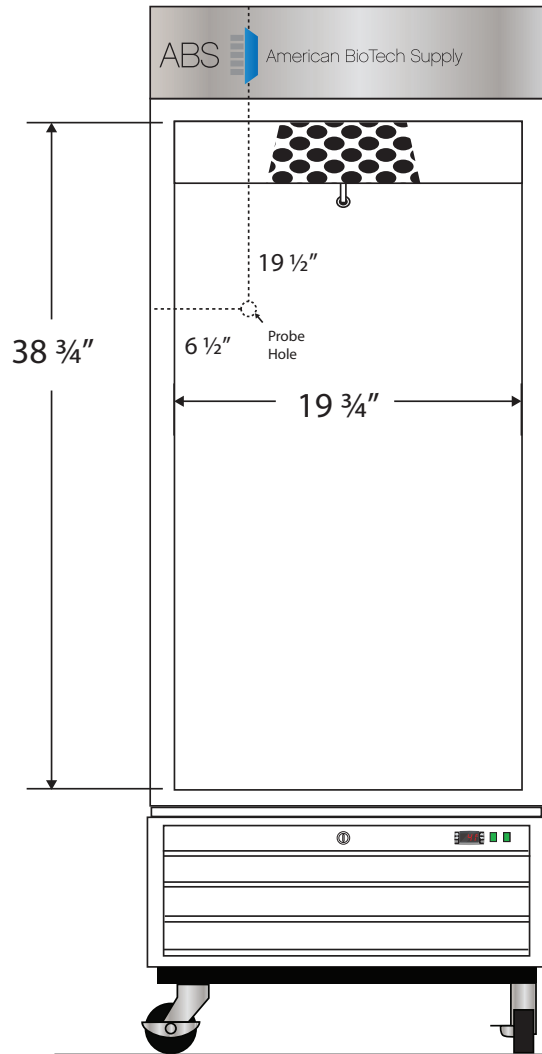

Side View

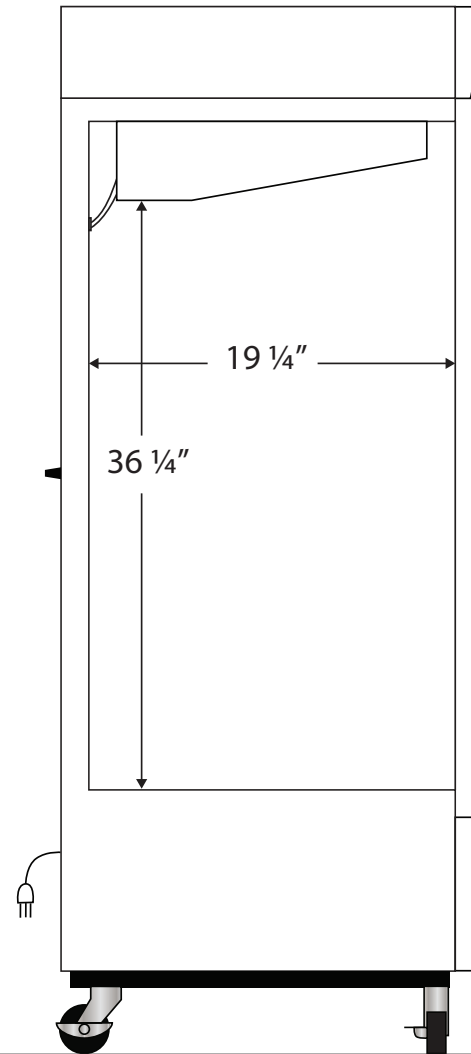

Cu. Ft	Defrost	Door	Int Door	Shelves	Interior Dim.			Refrigerant	H.P.	Amps	Weight
					W"	D"	H"				
12	Cycle	1 Glass	0	3 Adj	19 3/4	19 1/4	36 1/4	R290	1/5	3	218 lbs.

Note: Interior dimensions are estimates and subject to change without notice