

CUTSHEET

Front View

Side View

Top View

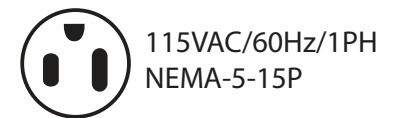
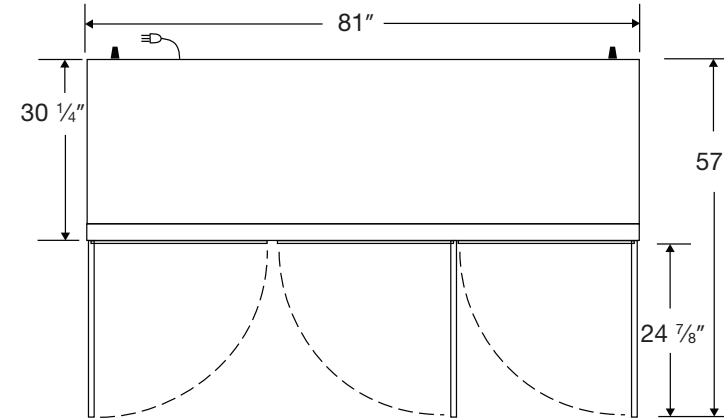
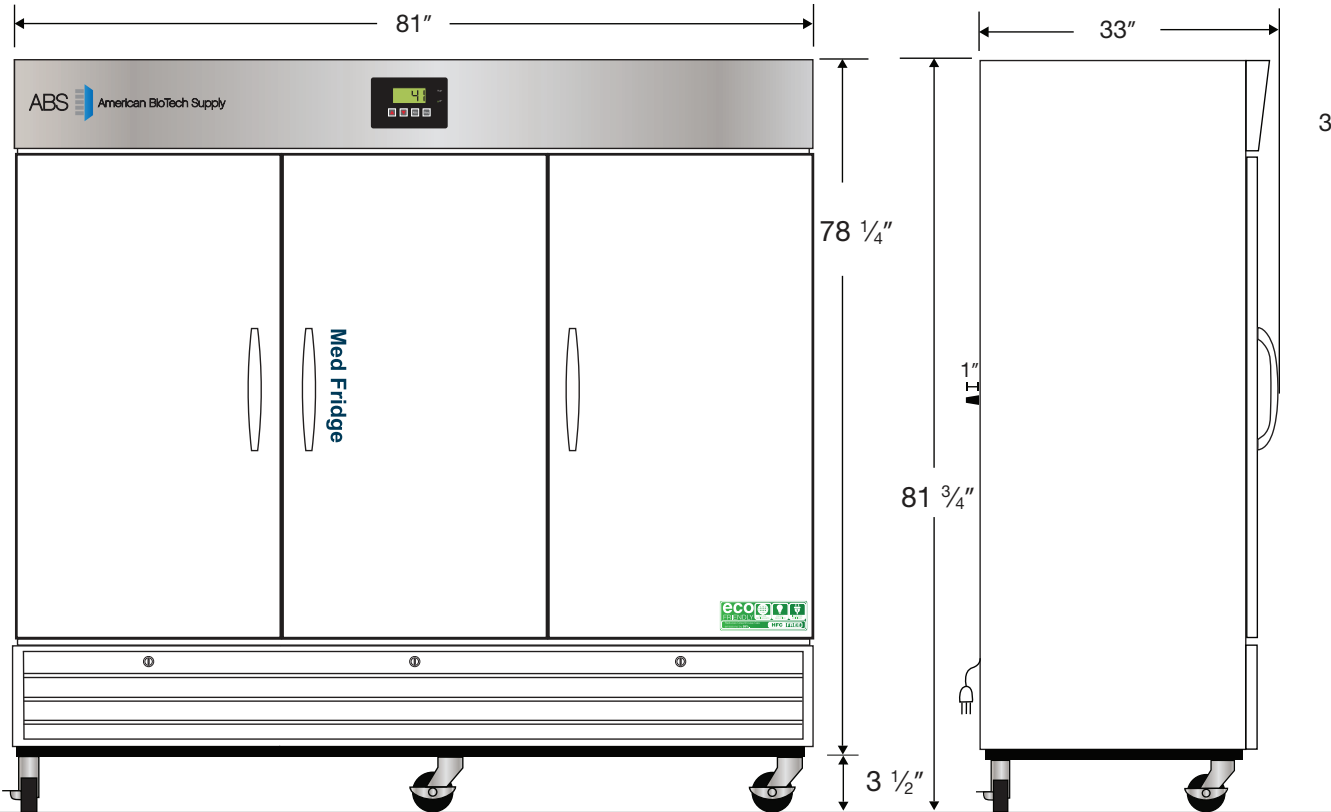

Cu. Ft	Defrost	Door	Int Door	Shelves	W"	D"	H"	Refrigerant	H.P.	Amps	Weight
72	Cycle	3 Solid	0	18 Adj.	81	34	81 3/4	R290	1/2	7.5	550 lbs.