

CUTSHEET

Front View

Side View

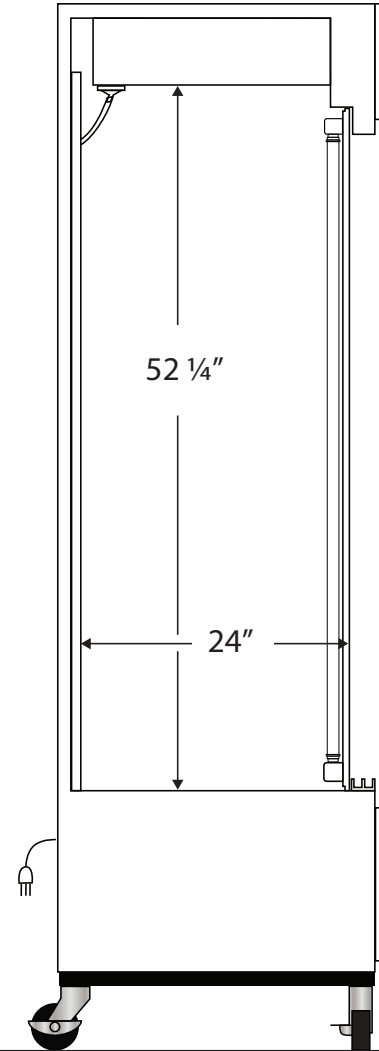
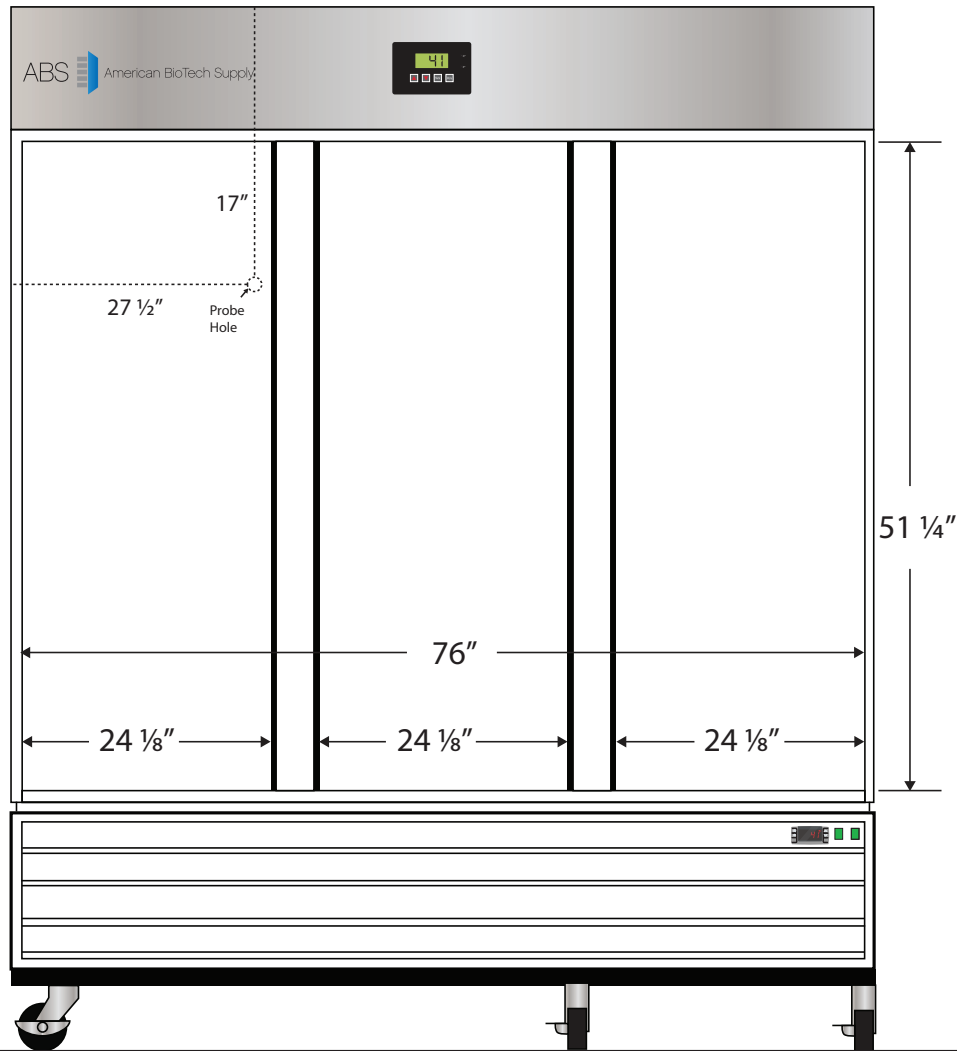

Cu. Ft	Defrost	Door	Int Door	Shelves	Interior Dim.			Refrigerant	H.P.	Amps	Weight
					W"	D"	H"				
69	Cycle	3 Glass (Sliding)	0	18 Adj	76	24	52 1/2	R290	1/2	7.5	688 lbs.

Note: Interior dimensions are estimates and subject to change without notice