

CUTSHEET

Front View

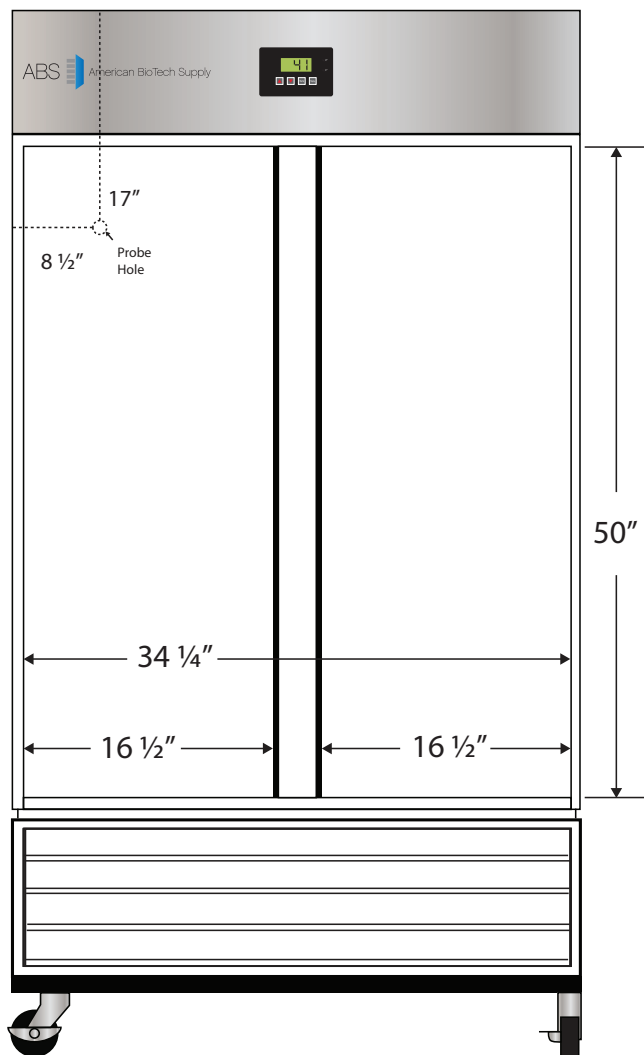

Side View

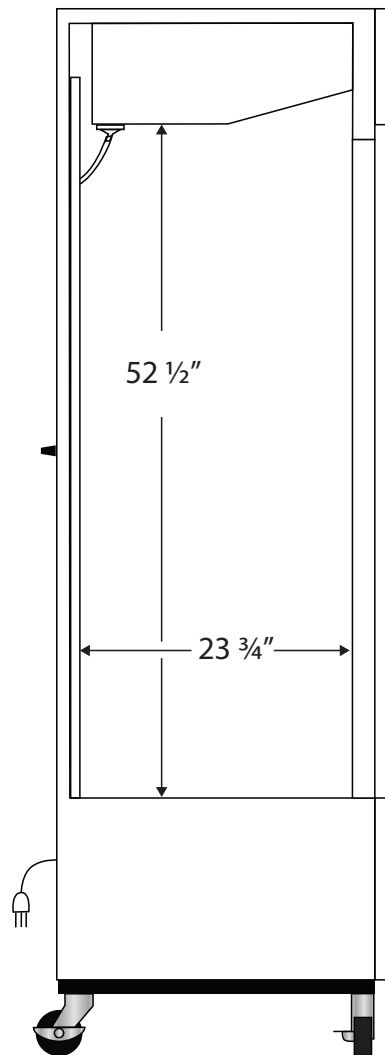

Cu. Ft	Defrost	Door	Int Door	Shelves	Interior Dim.			Refrigerant	H.P.	Amps	Weight
					W"	D"	H"				
33	Cycle	2 Glass (Sliding)	0	12 Adj	34 1/4	23 3/4	52 1/2	R290	1/4	4.5	369 lbs.

Note: Interior dimensions are estimates and subject to change without notice