

CUTSHEET

Front View

Side View

Top View

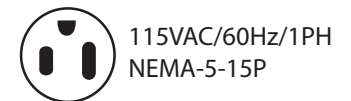
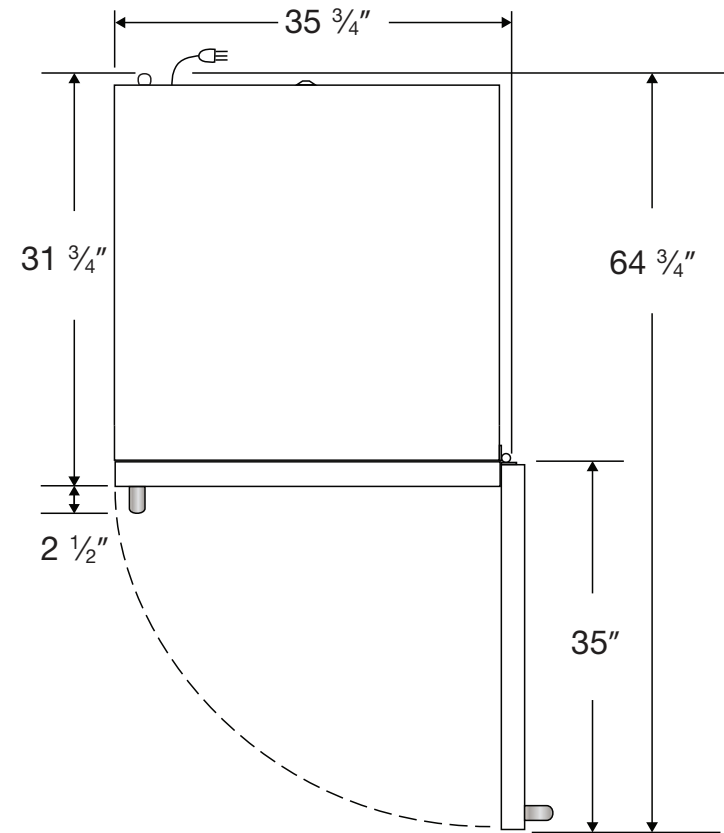
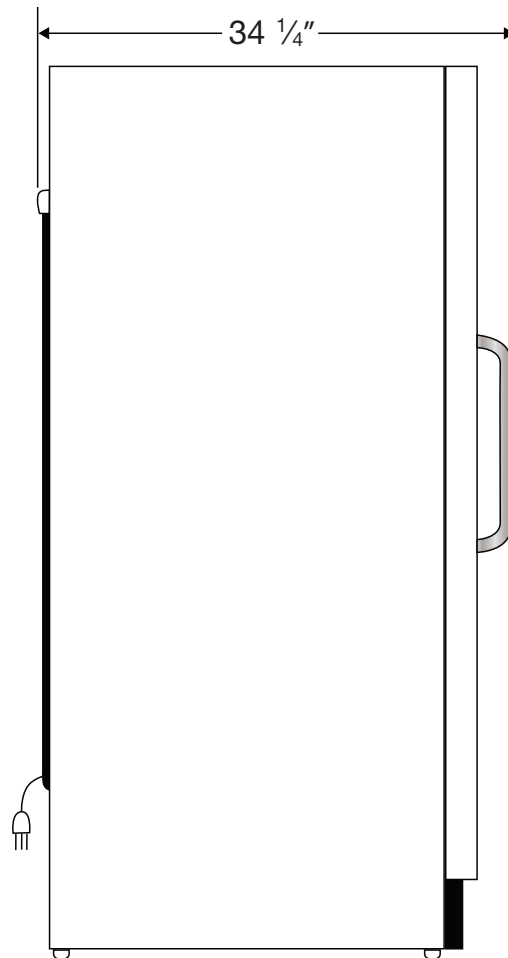
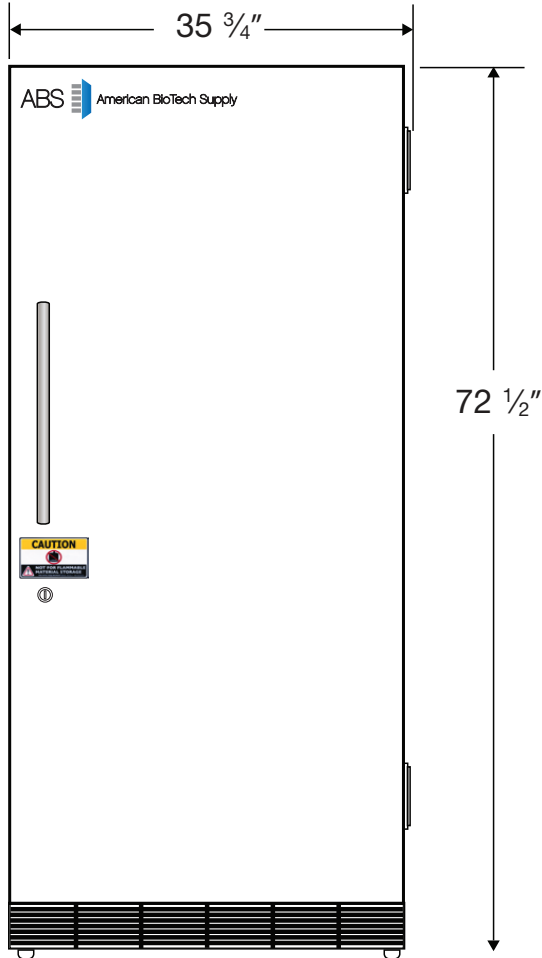

Cu. Ft	Defrost	Door	Int Door	Shelves	W"	D"	H"	Refrigerant	H.P.	Amps	Weight
30	Manual	1 Solid	0	4 Fixed	35 3/4	34 1/4	72 1/2	R404a	1/3	6	305 lbs.