

CUTSHEET

Front View

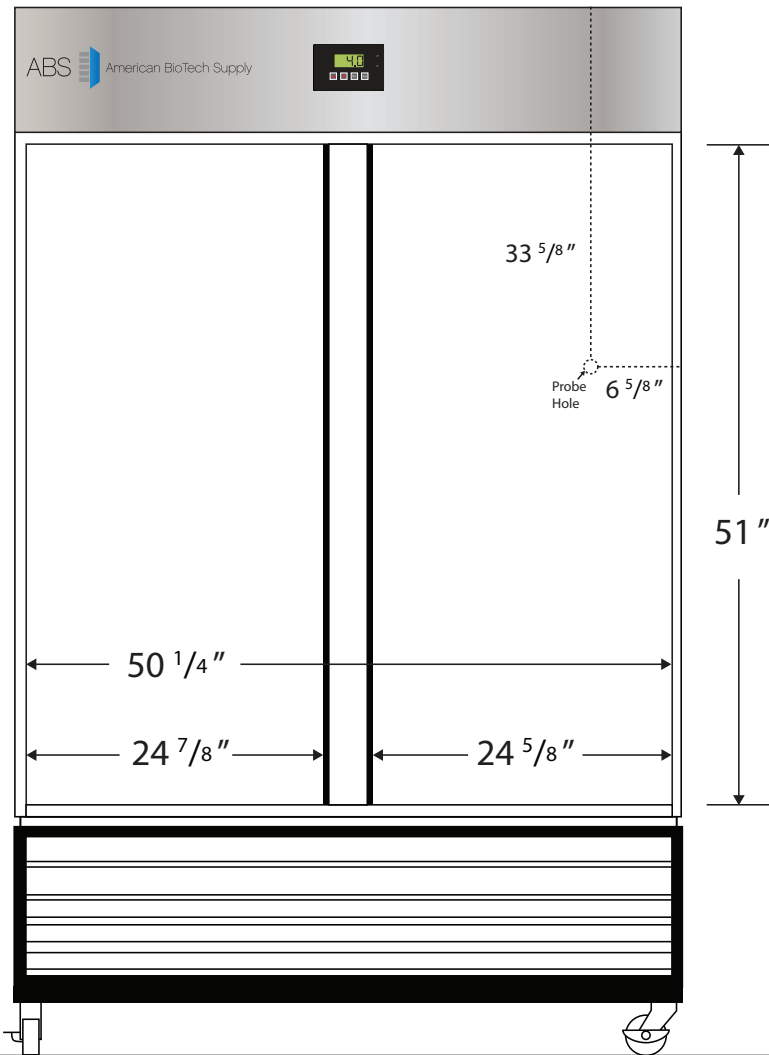

Side View

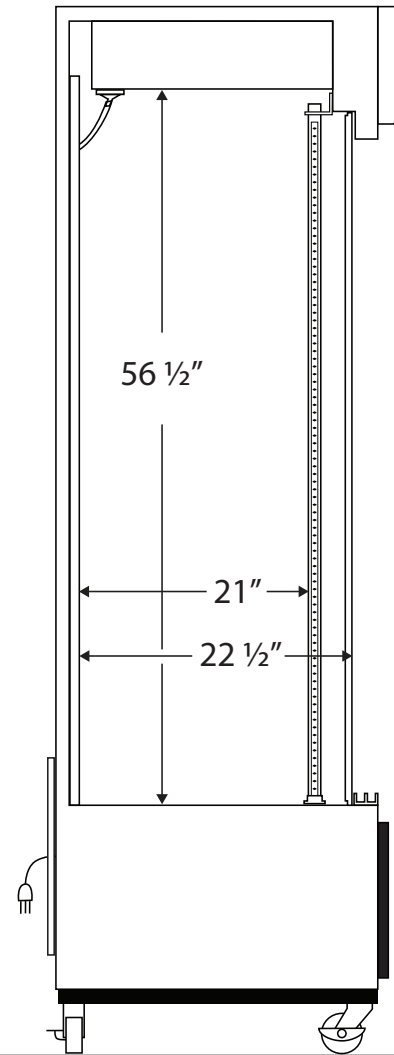

Cu. Ft	Defrost	Door	Int Door	Shelves	Interior Dim.			Refrigerant	H.P.	Amps	Weight
					W"	D"	H"				
47	Cycle	2 Slide	0	8 Adj	50 1/4	22 1/2	56 1/2	R290	1/2	8.5	455 lbs.

Note: Interior dimensions are estimates and subject to change without notice