

CUTSHEET

Front View

Side View

Top View

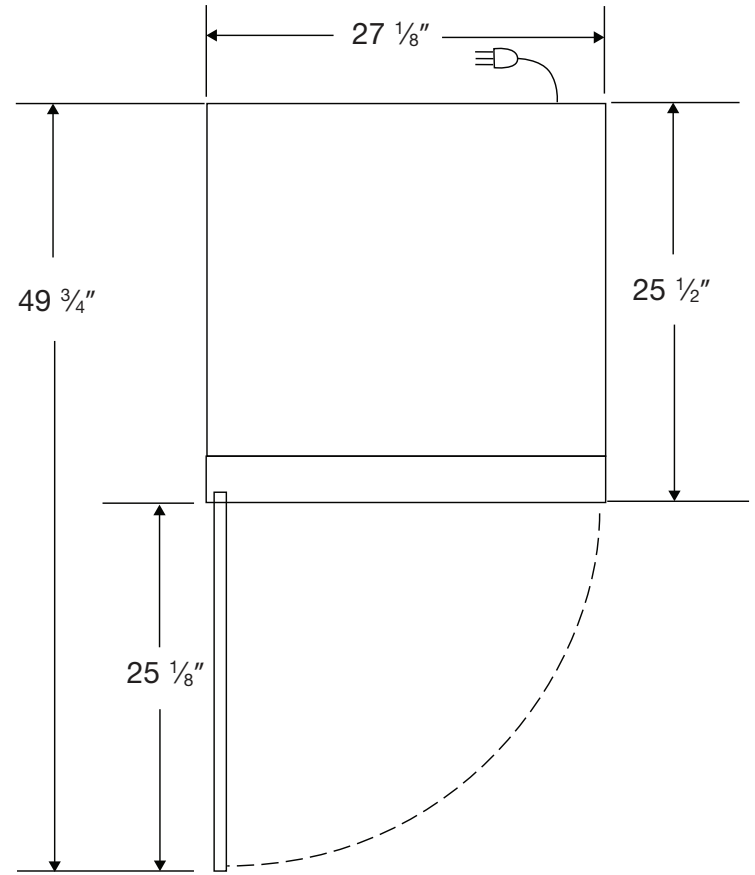
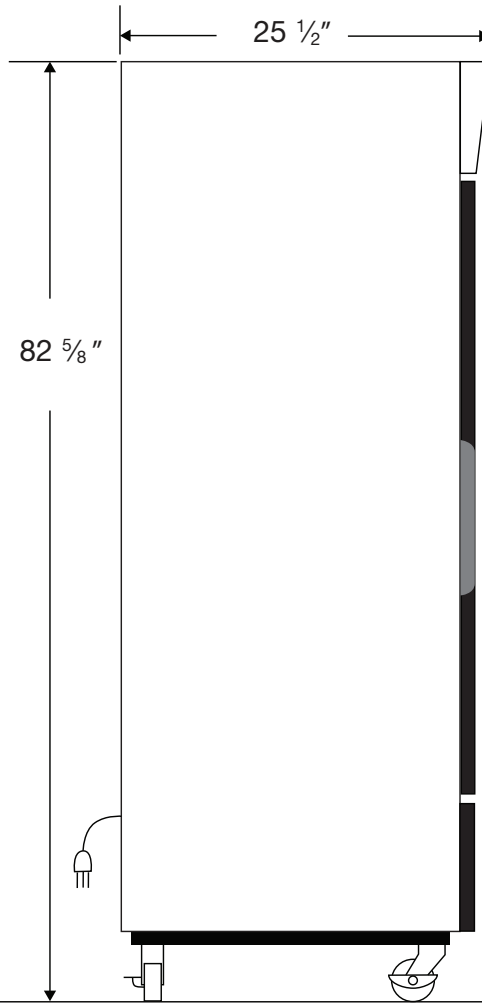
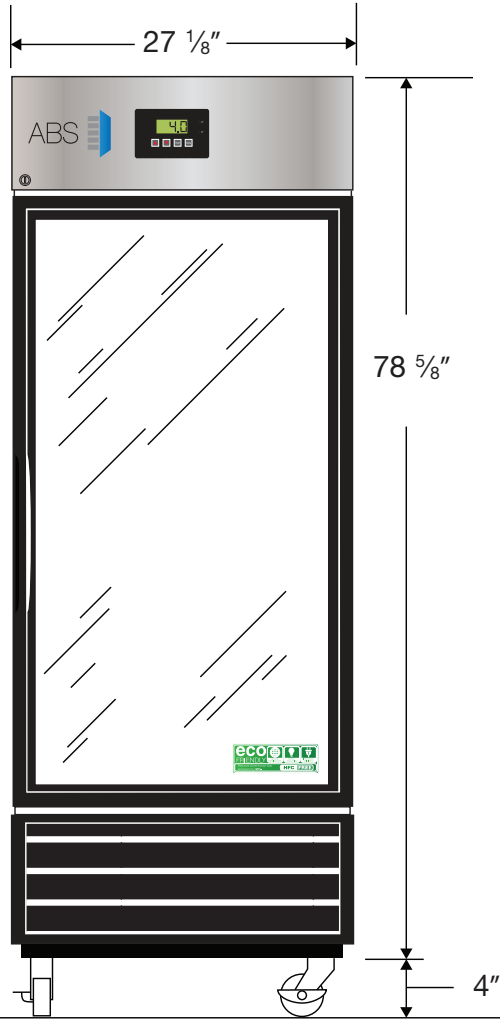

115VAC/60Hz/1PH
NEMA-5-15P

Cu. Ft	Defrost	Door	Int Door	Shelves	W"	D"	H"	Refrigerant	H.P.	Amps	Weight
19	Cycle	1 Glass	0	4Adj.	27 1/8	25 1/2	82 5/8	R290	1/3	5.4	255 lbs.